



Sesame Electric 2.1



Screen Materials

 **Arctiq** (gain 1.00)
The screen fabric has a matt white surface.

 **GreyLight** (gain 0.93)
The screen fabric has a high contrast matt grey surface.

 **Xpert** (gain 1.00)
Matt white, black-out fabric with excellent surface flatness and "green" environmental properties. Flame-retardant (B1).

Projection Formats

 **1 : 1**
SQUARE
The screen format is 1:1. No black borders.

 **4 : 3**
VIDEO
The screen has 5 cm wide black borders. The format of the viewing area is 4:3.

 **16 : 10**
DATA
The screen has 5 cm wide black borders. The format of the viewing area is 16:10.

 **16 : 9**
WIDE
The screen has 5 cm wide black borders. The format of the viewing area is 16:9.

Control Options

 **Installation**
5 metre cable. Needs to be installed by electrician. This is included as standard.

 **Remote Control**
The screen is operated by a 3 positions RF remote control.

 **AutoLink**
The screen goes automatically down/up when turning the projector on/off.

Euroscreen® Sesame 2.1 is an upgrade from the award winning, sophisticated recessed projection screen designed for installation in suspended or plastered ceilings. The model has a clever design of the bottom dowel which closes the case flush when the screen is not used, and the white aluminium case is equipped with unique removable end flanges for quick access and installation. The distinctive feature with a concealed drop function of screen section allows for installation in prepared ceiling cut-out later on during the construction process. The screen is stylish in its appearance with external flange profiles which are integrated with the case.

Optional brackets for trouble-free installation in recessed ceilings are available.

Screen Dimensions

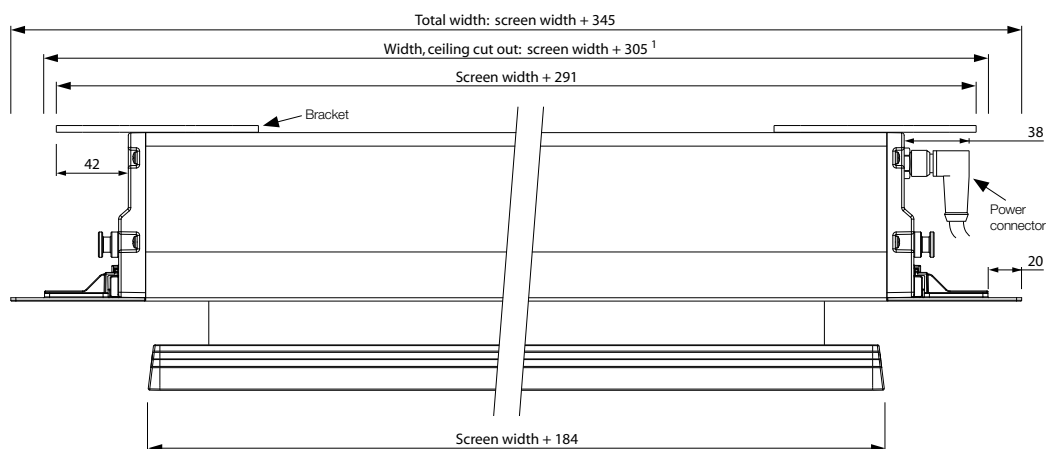

¹Considerations regarding cut out width

Minimum cut out width: screen width + 305
Maximum cut out width: screen width + 343
Recommended cut out width: screen width + 325

Example – Sesame Electric cut out dimension

Model: SEI240
Screen width: 2400
Rec. cut out width: $2400 + 325 = 2725$
Rec. cut out depth: 140
Needed height: 102

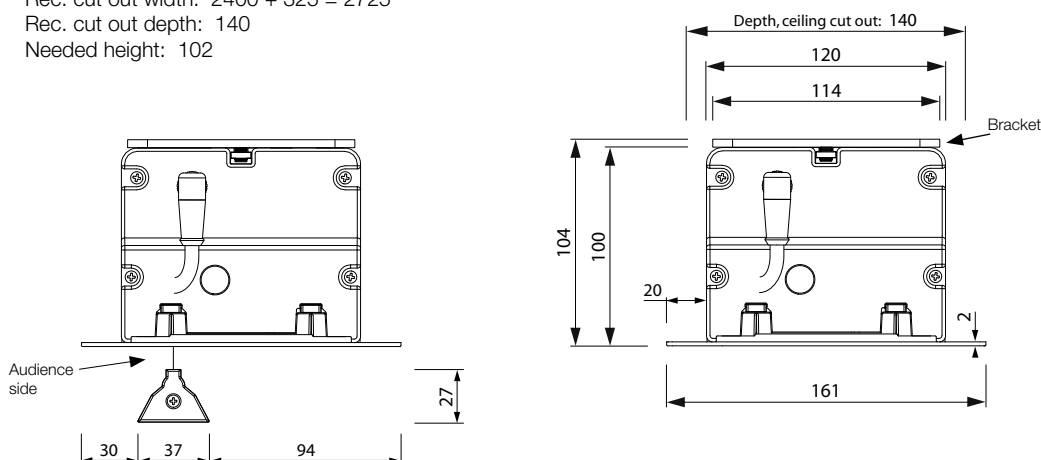

All dimensions in this document are in mm



Draper Europe AB
Kristinebergsvägen 22
SE-302 41 Halmstad
Sweden

Tel: +46 35 144290
Fax: +46 35 144291

Web: www.euroscreens.se

Electrical specifications

Motor Specifications

Voltage: 220 V Frequency: 50 Hz
 Power: 121 W Momentum: 6Nm
 Speed: 28 rpm Protection: IP44

The motor is grounded

Cable Specifications

Thickness: \varnothing 7 mm
 Cable area: $4 \times 0,5 \text{ mm}^2$, motor to control
 $3 \times 0,75 \text{ mm}^2$, control to plug
 Wires: Black - Up
 Brown - Down
 Blue - Neutral
 Green/Yellow - Ground



Installation cable

[Part no: 210673]

Enclosed with the screen.
 Weight - 0.40kg

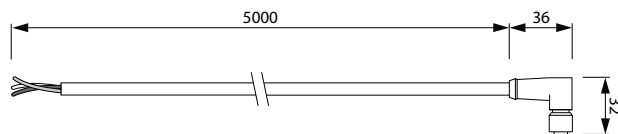

Other control options



Radio Transmitter

Part no: 210723

Delivered separately
 To be used with 210720.

Radio transmitter
 Weight - 0.40kg
 Batteries used: 2xAAA (incl.)



Radio Receiver Box

Delivered separately Part no Euro plug: 210720
 To be used with 210723. UK plug: 210720-UK

Receiver: 119 x 72 x 37 (0.810 kg, incl. cables)
 Package: 253 x 155 x 68
 Weight (incl. package) - 0.905kg



AutoLink

Part no Euro plug: 210700
 UK plug: 210700-UK

Communication - Infrared
 Receiver: 120 x 72 x 35 (0.42kg)
 Transmitter: 103 x 57 x 36 (0.26kg)
 Package: 710 x 105 x 56
 Weight all together - 0.87kg
AutoLink Extender recommended for Sesame.



AutoLink Extender

Part no: 210705

Delivered separately

Communication - Infrared
 Receiver: 40 x 33 x 15 (0.05kg)
 Transmitter: 43 x 30 x 16 (0.05kg)
 Package: 270 x 100 x 55
 Cable length: 1850 mm
 Weight all together - 0.20kg

Radio Remote

part of Remote Control

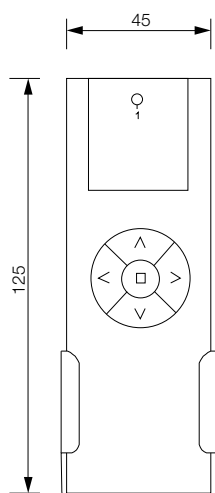

Receiver

part of Remote Control

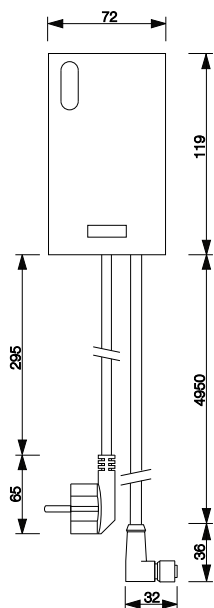

Receiver

part of AutoLink

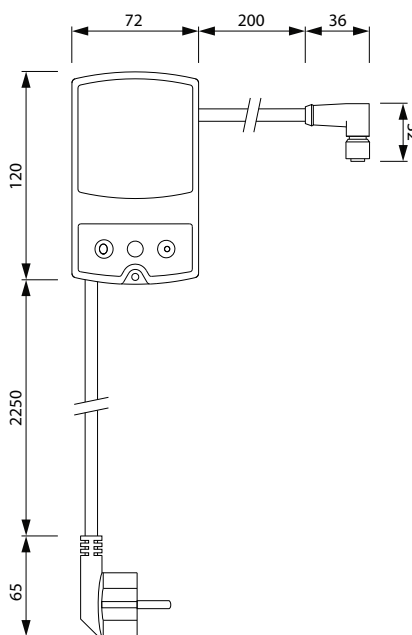

Transmitter

part of AutoLink

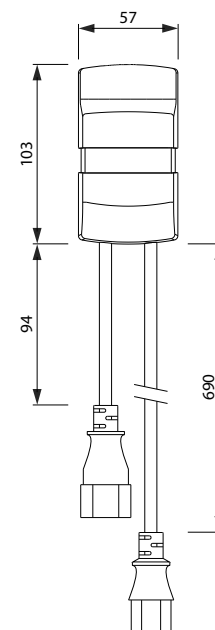

All dimensions in this document are in mm.



Draper Europe AB
 Kristinebergsvägen 22
 SE-302 41 Halmstad
 Sweden

Tel: +46 35 144290
 Fax: +46 35 144291

Web: www.euroscreens.se

Bracket Dimensions

Brackets are included in all Sesame products

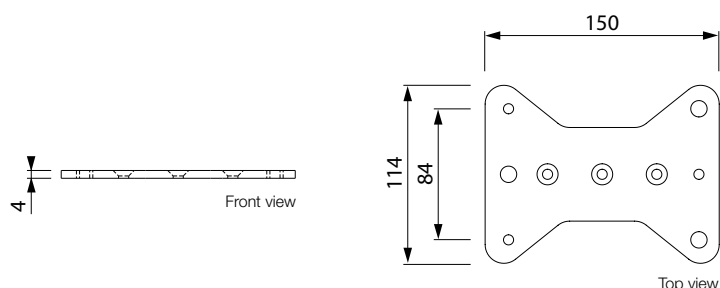
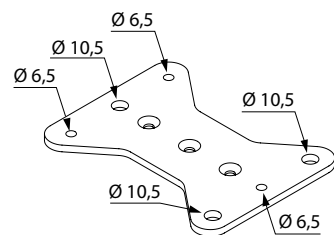

Packaging Dimensions

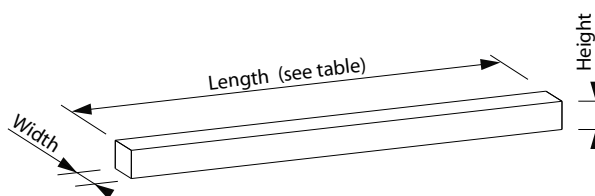

Screen width	Box length	Box width	Box height
1600	2040	250	255
1800	2240	250	255
2000	2440	250	255
2200	2640	250	255
2400	2840	250	255
2700	3140	250	255
3000	3440	250	255

Part Numbers for Sesame Electric 2.1

Square Format, 1 : 1

Video Format, 4 : 3

Wide Format, 16 : 9

Data Format, 16 : 10

PART. NO	SCREEN SIZE WIDTH x HEIGHT	WT. KG
SEI160	1600 x 1600	17,0
SEI180	1800 x 1800	18,0
SEI200	2000 x 2000	19,5
SEI220	2200 x 2200	21,0
SEI240	2400 x 2400	22,5
SEI270	2700 x 2700	24,0
SEI300	3000 x 3000	27,0

PART. NO	SCREEN SIZE WIDTH x HEIGHT	VIEW. AREA WIDTH x HEIGHT	WT. KG
SEI1617-V	1600 x 1750	1500 x 1125	17,0
SEI1817-V	1800 x 1750	1700 x 1275	18,0
SEI2017-V	2000 x 1750	1900 x 1425	19,5
SEI2217-V	2200 x 1700	2100 x 1575	21,0
SEI2420-V	2400 x 2050	2300 x 1725	22,5
SEI2724-V	2700 x 2100	2600 x 1950	24,0
SEI3024-V	3000 x 2350	2900 x 2175	27,0

PART. NO	SCREEN SIZE WIDTH x HEIGHT	VIEW. AREA WIDTH x HEIGHT	WT. KG
SEI1617-W	1600 x 1750	1500 x 845	17,0
SEI1817-W	1800 x 1750	1700 x 955	18,0
SEI2017-W	2000 x 1750	1900 x 1070	19,5
SEI2217-W	2200 x 1700	2100 x 1180	21,0
SEI2417-W	2400 x 1700	2300 x 1295	22,5
SEI2724-W	2700 x 2050	2600 x 1460	24,0
SEI3024-W	3000 x 2050	2900 x 1630	27,0

PART. NO	SCREEN SIZE WIDTH x HEIGHT	VIEW. AREA WIDTH x HEIGHT	WT. KG
SEI1617-D	1600 x 1750	1500 x 940	17,0
SEI1817-D	1800 x 1750	1700 x 1065	18,0
SEI2017-D	2000 x 1750	1900 x 1190	19,5
SEI2217-D	2200 x 1700	2100 x 1310	21,0
SEI2417-D	2400 x 1700	2300 x 1440	22,5
SEI2724-D	2700 x 2050	2600 x 1625	24,0
SEI3024-D	3000 x 2050	2900 x 1810	27,0

All weights are gross (total weight including packaging, brackets etc.).

Standard screen material is white.

Screens with Greylight are available in sizes with maximum height of 2400 mm. For part numbers with Greylight replace SEI by SEGI. Example: An 2217-W with Greylight fabric = SEGI2217-W

Screens with Xpert are available in all sizes. For part numbers with Xpert replace SEI by SXI. Example: An 2217-W with Xpert fabric = SXI2217-W

Accessories

ARTICLE NO	
930200	Recessed Ceiling Bracket
210603	Switch, 2-positions
210604	Keypress, 3-positions

ARTICLE NO	
400300	Screen Cleaning Spray, 250 ml

All dimensions in this document are in mm.

Document PDSSE ver 2.0, page 3 of 3



Draper Europe AB
Kristinebergsvägen 22
SE-302 41 Halmstad
Sweden

Tel: +46 35 144290
Fax: +46 35 144291

Web: www.euroscreens.se

rev.date: 03 okt 2011